



POWERSPORTS

CAUTION

THIS ATV WAS SHIPPED WITHOUT ENGINE OIL. ALWAYS FILL WITH THE CORRECT AMOUNT AND GRADE OF ENGINE OIL AS LISTED IN THE OWNER'S MANUAL

ASSEMBLY/PRE-RIDE INSPECTION INSTRUCTIONS

AT125EX

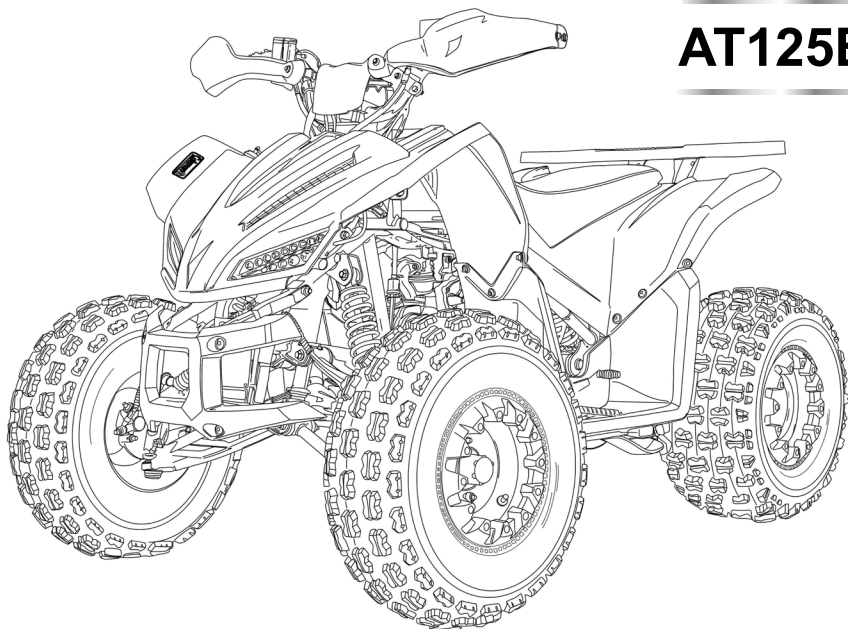

FOR QUESTIONS ABOUT THESE ASSEMBLY INSTRUCTIONS,
CALL COLEMAN POWERSPORTS (888) 405-8725



WARNING

NEVER ATTEMPT TO START THIS ATV WITHOUT READING AND UNDERSTANDING THE OWNER'S/ OPERATOR'S MANUAL. THE OWNER'S/ OPERATOR'S MANUAL PROVIDES INFORMATION ON SAFETY, PARTS, FUNCTIONS, PRE-RIDE INSPECTION, STARTING AND MAINTENANCE

PARTS

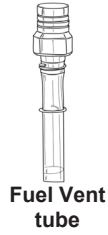
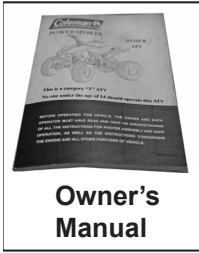

Tie Rod Assembly

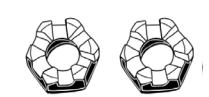

M10 Castle nuts



M3 cotter pins



M10 Lock Washers

Front Bumper Assembly

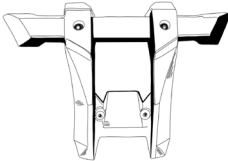

Front Bumper

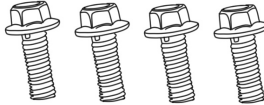

M8 x 20 Bolts



M8 Lock nuts

Rear Carrier Assembly

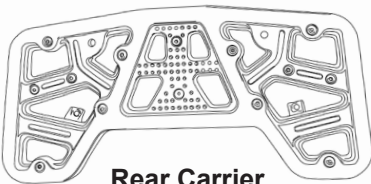

Rear Carrier

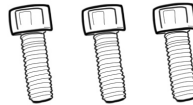

M8x25 Socket head bolts

Battery Assembly



Battery (1)

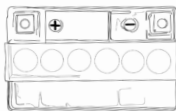

Battery Strap (2)



Battery Changer

PARTS

Handlebar Assembly

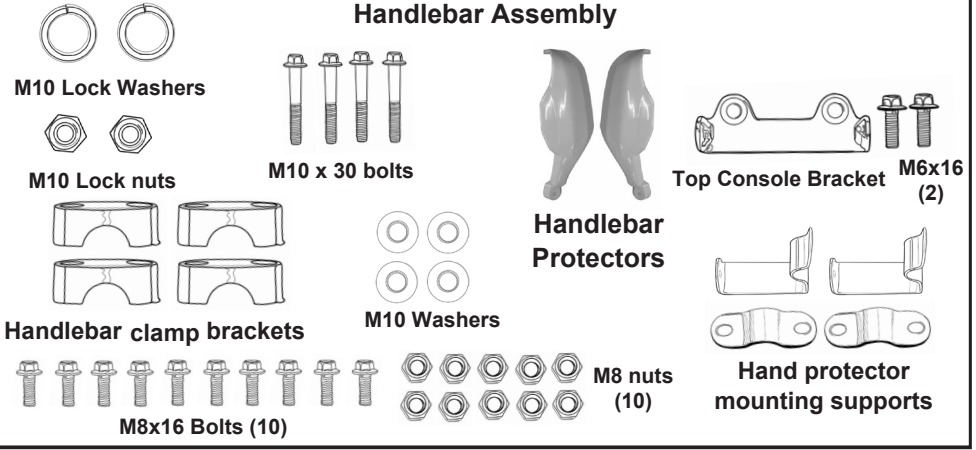

Tire Assembly

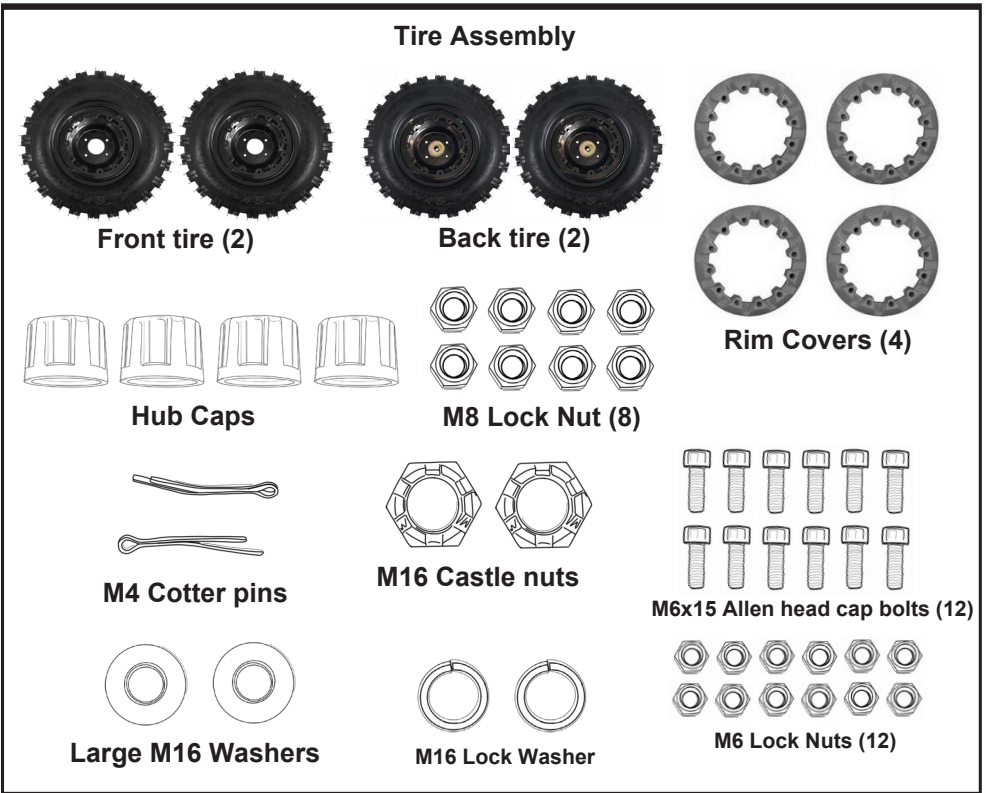

HANDLEBAR ASSEMBLY



Handlebar clamp brackets



Top Console Bracket M6x16 (2)



M10 Lock Washers



M10 x 30 bolts



M10 Washers



M10 Lock nuts

Handlebar clamp bracket

Steering assembly bracket

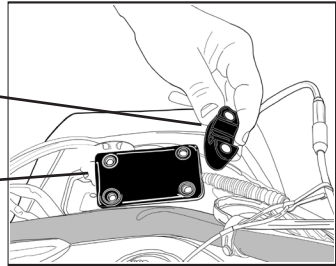

1. Attach bottom clamp brackets to steering assembly bracket using M10 x 30 bolts, M10 lock washers and M10 lock nuts

Top Console Bracket

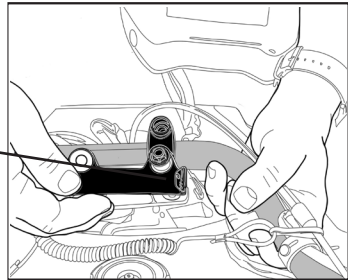

Handlebar

Top Console Bracket



M10 x 30 bolt

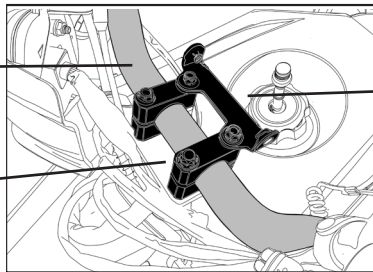

ODOMETER ASSEMBLY

Speed-odometer
Console

Top Console Bracket

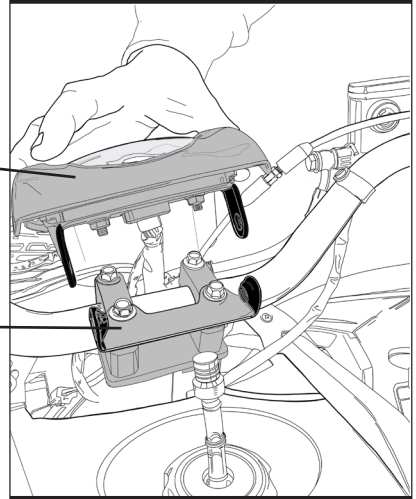

1. Install the odometer assembly with 2 M6x16 bolts on the top console bracket

M6x16 bolt

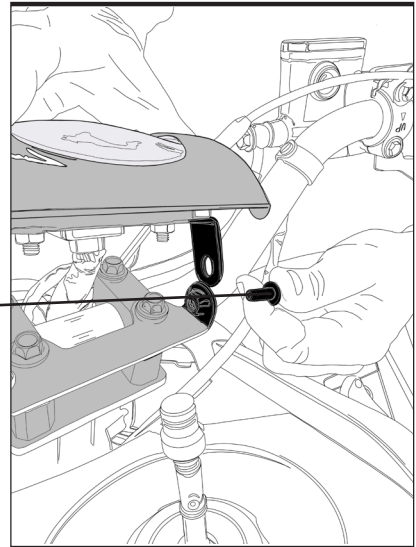

HANDLEBAR ASSEMBLY

Right/Left Brake Lever Install

1. Plug the black and green wires into the right and left brake assemblies

Black and green wires

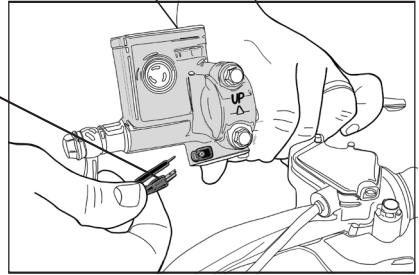

2. Install the right and left brake assemblies using the M6x20 bolts

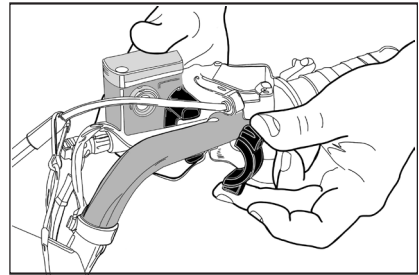

M6x20 bolts

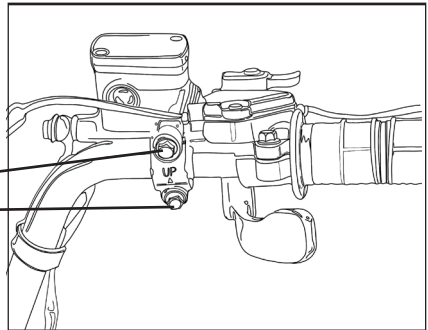

HAND PROTECTOR ASSEMBLY

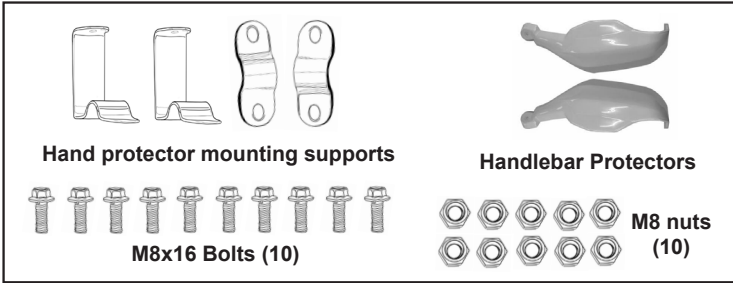

1. Attach hand protectors by placing the mounting supports around the handlebar as shown in the last photo. Secure with M8x16 bolt and nut five times per handle bar

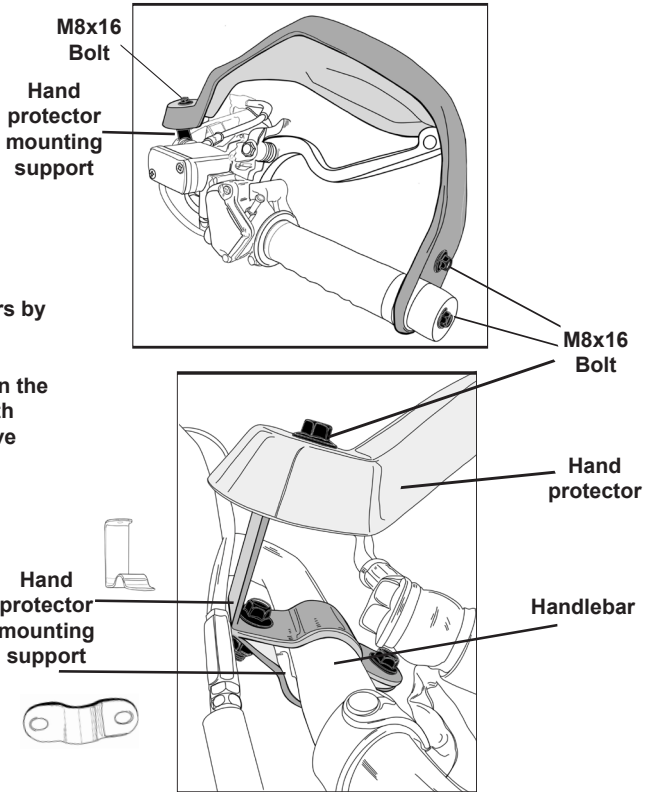

TIE ROD INSTALLATION

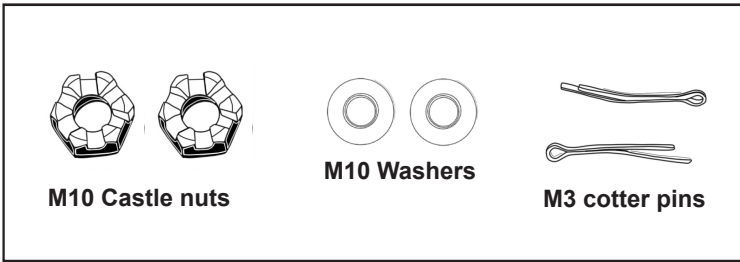

1. Attach tie rod to front spindle assembly on both sides of ATV
2. Secure tie rod using M10 washer and M10 castle nut. Tighten snug
3. Insert cotter pin then bend over ends pin will not back out

Front spindle assembly

Tie Rod

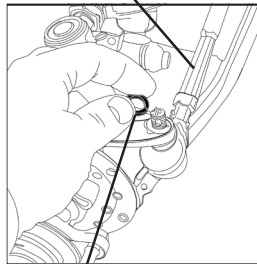
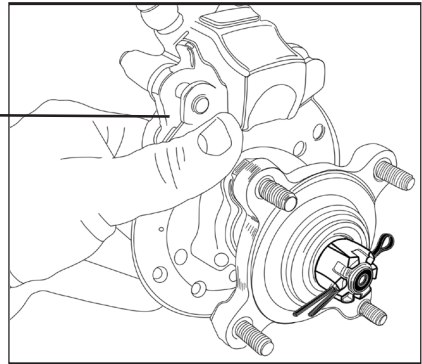

M10 Washer

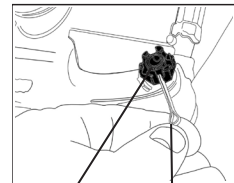

Castle Nut

Cotter Pin

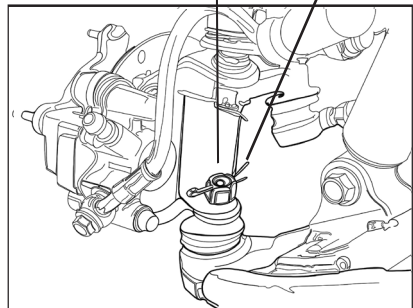

RIM INSTALL

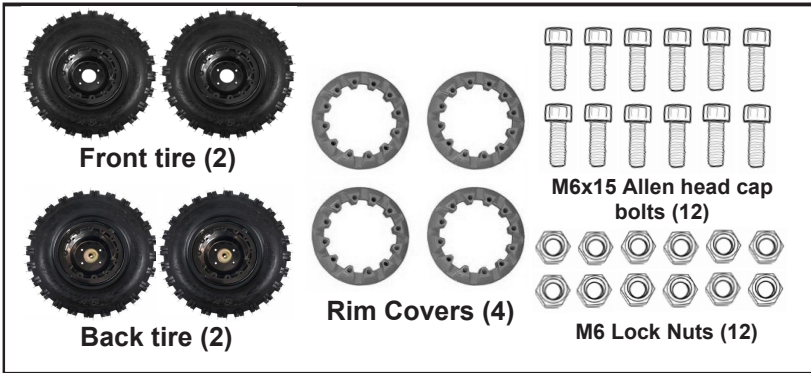

1. Place rim cover on tire, matching up the holes of the rim to the holes of the tire

2. Screw in allen head cap bolt through every fourth hole.

Three nuts and bolt per tire.

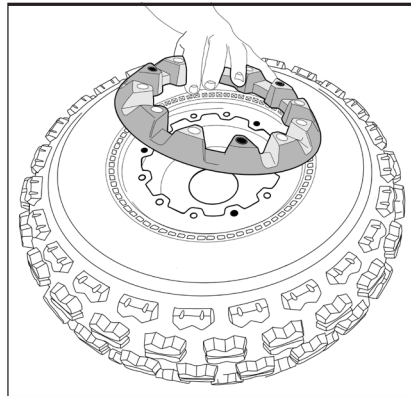

M6x15 Allen head cap bolt

M6 Lock Nuts

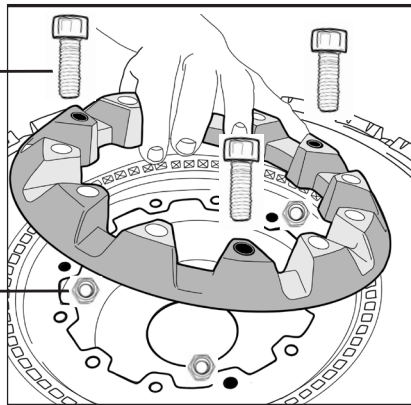

REAR WHEEL INSTALL

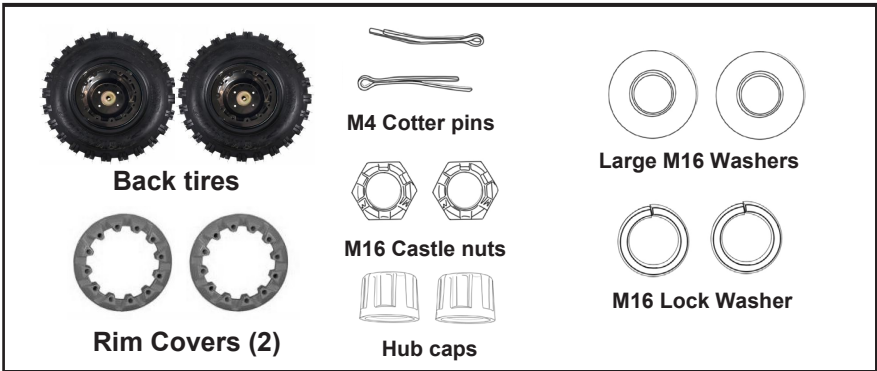

NOTE: Fill tires with 4 PSI of air before assembly.

1. Slide rear wheels on rear axle assembly. Make sure valve stem on tire faces out.

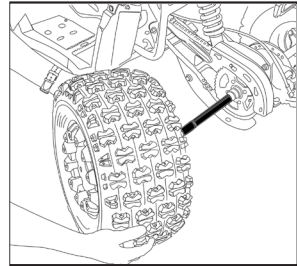

2. Attach wheel with large M16 Washer and M16 Lock Washer

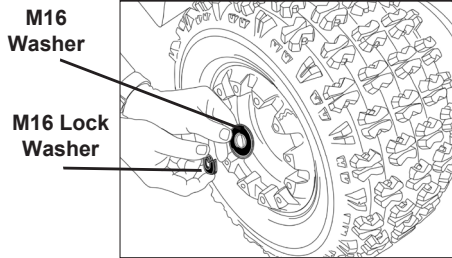

3. Attach Castle nut. Tighten snug

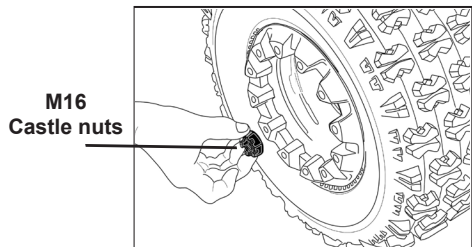

REAR WHEEL INSTALL

4. Install cotter pin and bend over ends.

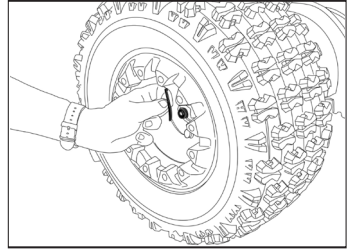

5. Install hub caps

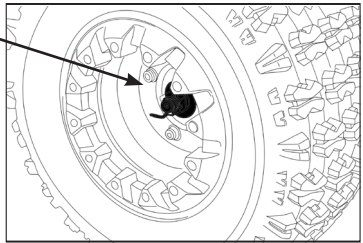

FRONT WHEEL INSTALL

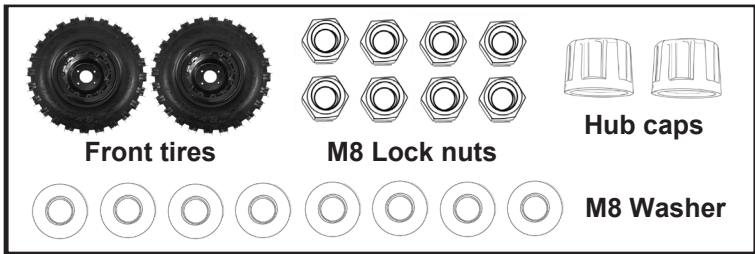

NOTE: Fill tires with 4 PSI of air before assembly.

1. Install front wheels. Make sure valve stem faces out.

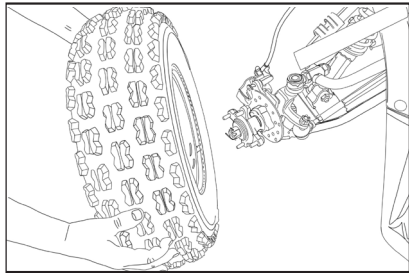

2. Attach wheel with M8 washer, followed by M8 lock nut. Repeat this four times for each front wheel.

Torque nuts
20 ft.lbs.(27 Nm)

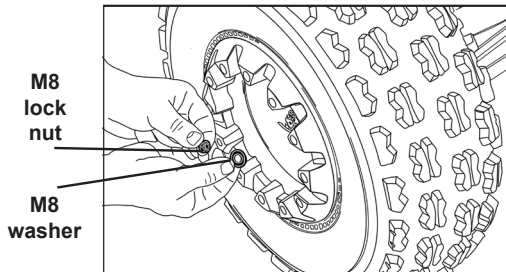

3. Install hub cap

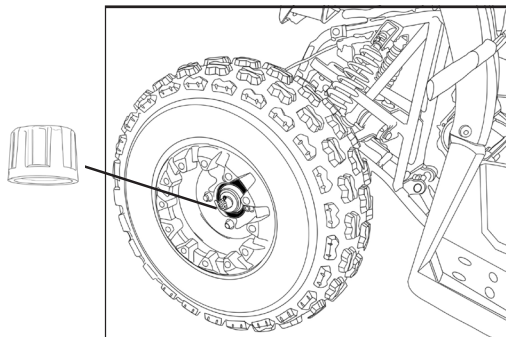

FRONT BUMPER INSTALL

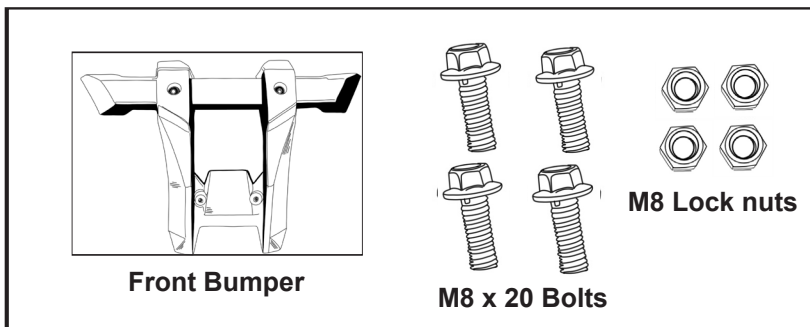

1. Install front bumper with M8 x 20 bolts and M8 lock nuts.

M8x20 bolt

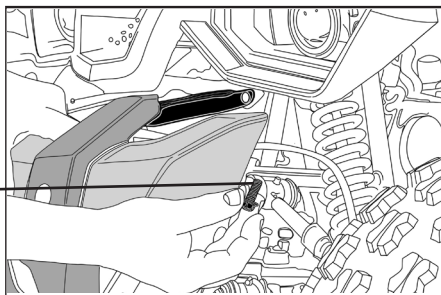

M8x20 bolts

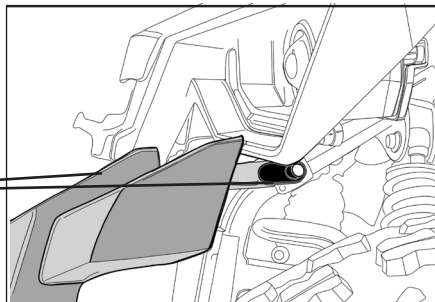

M8x20 bolts

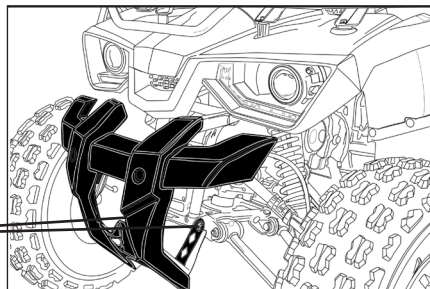

REAR CARRIER INSTALL

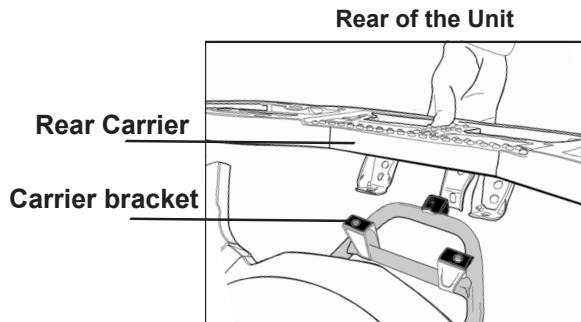
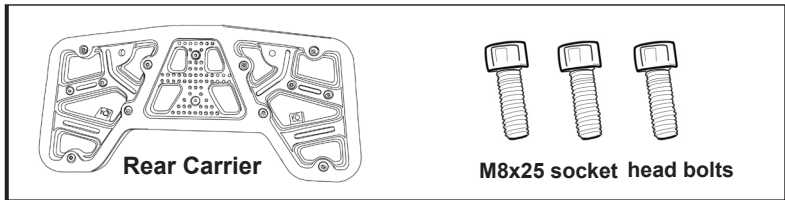

1. Fix the rear carrier on the carrier bracket with bolt M8x25 and lock nut M8

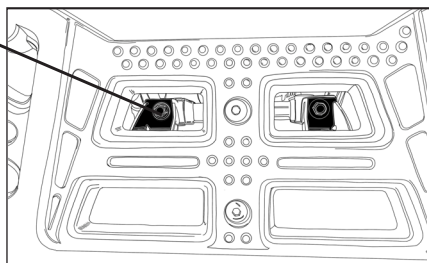
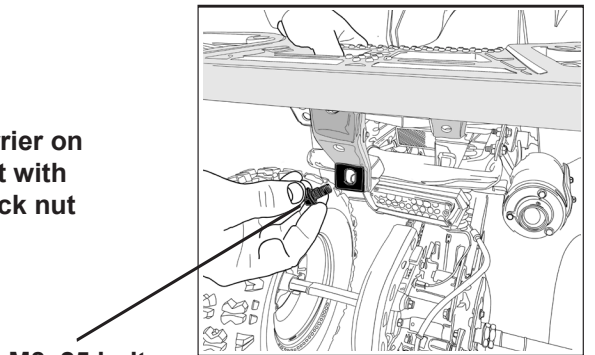

BATTERY INSTALLATION

⚠ WARNING

Battery electrolyte (sulfuric acid) is poisonous, electrolyte can cause severe burns if contacts skin. Avoid contact with skin, eyes or clothing.

If sulfuric acid is swallowed or splashed in the eyes, treat immediately. Sulfuric acid in the eyes can cause blindness. Serious internal injuries or death can result if swallowed.

ANTIDOTES: For acid on the skin, flush with water.

If acid is swallowed, drink large quantities of milk or water, followed by milk of magnesia, vegetable oil or beaten eggs. Do not induce vomiting. Call a poison control center or doctor immediately. For acid in the eyes, flush for several minutes with water and seek immediate medical attention.

Make sure work area is well ventilated.

Always wear goggles or face shield when working with the battery.

Always wear protective plastic gloves to protect hands.

Always wear a protective smock to protect clothing.

Battery preparation

1. Remove battery (1) and electrolyte bottle (2) from the box. Remove battery cap strip (3) from electrolyte bottle
2. Pull tape strip (4) off top of battery and discard.
3. Turn electrolyte bottle over and place on top of battery pushing firmly until the battery nozzle tips puncture the film over the spouts. Allow all electrolyte to flow into the battery. Note: Dispose of electrolyte bottle properly
4. Install battery cap strip (3). Let battery sit for 1/2 hour before charging. Note: The battery is a sealed type battery once the cap is in place. There is no maintenance to fluid level. Never re-open once caps are in place.

Step 1

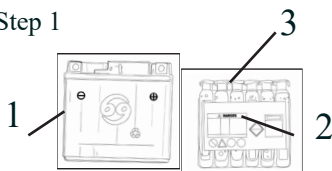

Step 2

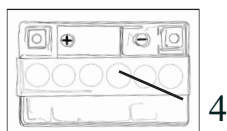

Step 3

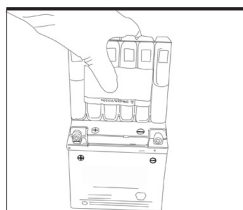

Step 4

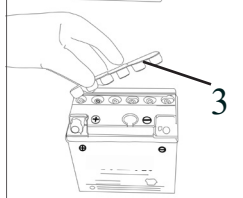

Charging the battery

Note: Do not turn the charger on before attaching the charger clips to the battery terminals.

The standard charging rate is 0.7A x 5-10 hours. Maximum charging rate is 3A x 1hour

1. Attach the Charger to the battery terminals. Red clip to the POS + side of the battery. Black clip to the NEG - side of the battery.
2. Plug in the charger and turn on making sure it is set at the correct settings.
3. Once battery is charged, unplug the charger before disconnecting the POS + and NEG- clips



**Battery
Charger**

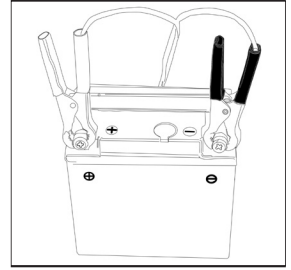

⚠ WARNING

If not performed the correct way, charging the battery could be hazardous.

While charging battery, keep away from sparks and open flames. The battery gives off explosive gases.

Always connect the charger to the battery before turning the charger on, this prevent sparks when attaching the terminal clips to the battery.

Always unplug the charger before disconnecting the battery from the charger, this will prevent sparks when removing the terminal clips

CAUTION

Reversing the battery lead wires can damage the charging system and the battery.

The red lead (clip) must go to the POS (+) side of the battery.
The black lead (clip) must go to the NEG (-) side of the battery.

Installing the battery

1. Install battery in battery bracket located underneath the seat of the ATV.
2. Attach the red wire to the POS + side of the battery with screws provided. Attach the black wire to the NEG - side of the battery with screws provided. Make sure the connections are tight.
3. Install the rubber straps to hold the battery in place.

Wire attachment points

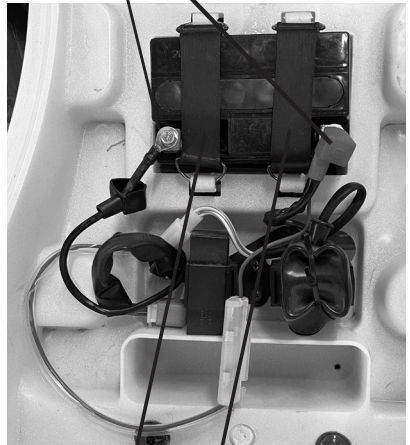

Rubber strap

⚠ WARNING

NEVER ATTEMPT TO START THIS ATV WITHOUT READING AND UNDERSTANDING THE OWNER'S/ OPERATOR'S MANUAL. THE OWNER'S/ OPERATOR'S MANUAL PROVIDES INFORMATION ON SAFETY, PARTS, FUNCTIONS, PRE-RIDE INSPECTION, STARTING AND MAINTENANCE



POWERSPORTS

(888) 405-8725

1775 E. University Dr., Tempe, AZ 85281

www.colemanpowersportsusa.com

www.facebook.com/colemanpowersportusa.com

www.instagram.com/colemanpowersports_usa

